



Lane/5000

User Guide



www.ingenico.com

28-32, boulevard de Grenelle, 75015 Paris - France / (T) +33 (0)1 58 01 80 00 / (F) +33 (0)1 58 01 91 35

Ingenico - SA au capital de 47 656 332 / 317 218 758 RCS Nanterre

● SEAMLESS PAYMENT

Contents

1_Introduction _____	4
2_Unpacking _____	5
3_Recommendations _____	6
3_1 Safety _____	6
3_2 Security of your terminal (tampering attempt detection) _____	7
3_3 Main Characteristics _____	9
3_3_1 Terminal _____	9
3_3_2 Powercharacteristics _____	10
4_Installation _____	12
4_1 Positioning the terminal _____	12
4_2 Connections _____	13
4_3 Installing the Terminal _____	14
4_3_1 Installing SAM (Secure access module, optional) _____	14
4_3_2 Installing MicroSD Card (optional) _____	15
4_3_3 Connecting the terminal to the host _____	16
4_4 USB port (optional) _____	19
4_5 Stylus pen (optional) _____	19

● SEAMLESS PAYMENT

5_Daily use _____	20
5_1 Card reading _____	20
5_1_1 Swiping a card _____	20
5_1_2 Inserting a smart terminal _____	20
5_1_3 Reading a contactless card _____	20
5_2 Keyboard details and functionality _____	21
5_3 Signature capture (optional) _____	22
5_4 Audio jack (optional) _____	22
6_Maintenance _____	23
6_1 Cleaning of the terminal _____	23
6_2 Transport and storage _____	24
6_3 Troubleshooting _____	24
6_4 Environment (WEE, Batteries and Packaging) _____	25
7_Standards _____	26
7_1 CE Marking _____	26
7_2 WARNING TO USERS IN THE UNITED STATES _____	6
7_3 NO UNAUTHORIZED MODIFICATIONS _____	27
7_4 ANTENNA REQUIREMENT _____	27
7_5 WARNING TO USERS IN THE CANADA _____	27

1_Introduction

Thank you for choosing an Ingenico payment terminal.

We recommend you to read carefully this user guide: it gives you the necessary information about safety precautions, unpacking, installation and maintenance of your terminal.

WARRANTY / SECURITY



To benefit from the guarantee-related product, and to respect the security, we ask you to use only the Ingenico power supply entrusting maintenance operations only to an authorized person.

Failure to comply with these instructions will void the manufacturer's responsibility.



This symbol indicates an important Warning.



This symbol indicates a piece of advice.

● SEAMLESS PAYMENT

2_Unpacking

According to the model, the following items are included in the packaging box (including optional accessories):

> The terminal



> The installation guide



The box may also include the following items depending on your working configuration:

- > **Cable (specific to your connectivity requirements)**
- > **Power supply unit and power cord**
- > **A stylus and its holder**
- > **Screws to fix the main cable and the trap door**



CAUTION

The power supply unit provided with your equipment is designed for it. It is certified with the Lane/5000. Do not use any other power supply.



ADVICE

Keep the packaging. It must be re-used whenever the terminal is shipped.

● SEAMLESS PAYMENT

3_Recommendations

3_1 Safety

Power on/Power down - Emergency stop

To power on or power down the terminal, connect or disconnect the power supply from the electric outlet.

Power supply unit



CAUTION

Only use the power supply AC/DC provided with Lane/5000 (8VDC 2A, 8VDC 3A, 12VDC 2,5A or 8VDC 4A) or the power provided by a cash register limited power source (LPS).

Authorized power supply units :

Power Supply Unit Supplier	Type	Supplier reference	Electrical characteristics	Ingenico part number
PHIHONG TECHNOLOGY Co. Ltd	Desktop	PSM32W-080	8VDC 4A Class V	296186619
PHIHONG TECHNOLOGY Co. Ltd	Wallplug	PSC16A-080L6IN-R PSC16E-080L6IN-R	8VDC 2A Class VI	296196003 296199611
PHIHONG TECHNOLOGY Co. Ltd	Desktop	PSM24W-080L6IN-R	8VDC 3A Class VI	296198809
PHIHONG TECHNOLOGY Co. Ltd	Desktop	PSAC30U-120L6INA-R	12VDC 2,5A Class VI	296204884AB

PSU class VI must be used in US.

● SEAMLESS PAYMENT



CAUTION

Use only the power supply specified for this product and certified for the country of use. If the power supply is not provided with the product, please contact your reseller.

Desktop Power Supply units have to be connected to the mains with one of these cables:

- Power cord 189609046 (European plug)
 - Power cord 188413214 (US plug)
-

CAUTION**Lithium battery cell**

The terminal is fitted with a lithium battery cell which is not accessible to the user. Only a qualified technician is authorized to open the unit and change this component.

Risk of explosion if the battery is replaced by an incorrect type. Dispose of used battery according to the instructions.

Electrical power supply network

- The electrical outlet must meet the following criteria;
- Must be installed near the equipment and easily accessible;
- Must meet standards and regulations in the country of use.
- For type A plug, the protection of the installation must be set to 20 A.

Explosion areas

Certain regulations restrict the use of radio equipment in chemical plants, fuel depots and any site where blasting is carried out. You are urged to comply with these regulations. The terminal shall be protected by a specially fitted and certified cover enabling use in proximity to a fuel pump.

Bottom side compartment trapdoor

Located under the terminal, it must be in place during normal operation of the device.

3_2 Security of your terminal (tampering attempt detection)

Your device fulfils current applicable PCI PTS security requirements. Upon receipt of your terminal you should check for signs of tampering of the equipment. It is strongly advised that these checks are performed regularly after receipt. You should check, for example: that the keypad is firmly in place; that there is no evidence of unusual wires that have been connected to any ports on your terminal or associated equipment, the chip card reader or any other part of your terminal.

● SEAMLESS PAYMENT

Such checks would provide warning of any unauthorised modifications to your terminal, and other suspicious behaviour of individuals that have access to your terminal.

Your terminal detects any "tampered state". In this state the terminal will repeatedly flash the message "Alert Irruption!" and further use of the terminal will not be possible. If you observe the "Alert Irruption!" message, you should contact the terminal helpdesk immediately.

You are strongly advised to ensure that privileged access to your terminal is only granted to staff that have been independently verified as being trustworthy.

The terminal must never be put in or left at a location where it could be stolen or replaced by another device.

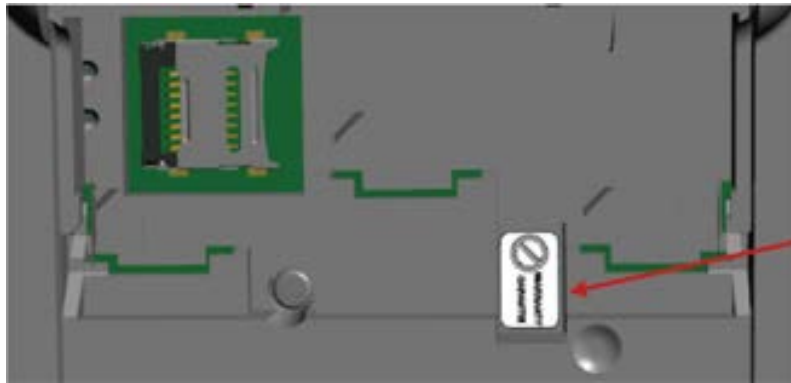

**Warranty label
(under the
trapdoor)**



WARNING

If the warranty label is torn or removed, the warranty will be void.



CAUTION

Positioning of the Lane/5000 on check stand must be in such a way to make cardholder PIN (Personal Identification Number) spying infeasible.

Installing device on an adjustable stand must be in such a way that consumers can swivel the terminal sideways and/or tilt it forwards/backwards to a position that makes visual observation of the PIN-entry process difficult.

Positioning of in-store security cameras such that the PIN-entry keypad is not visible.

NEVER ask the customer to divulge their PIN Code. Customers should be advised to ensure that they are not being overlooked when entering their PIN Code

● SEAMLESS PAYMENT

3_3 Main Characteristics

3_3_1 Terminal

Processor	Application & Crypto processor	Cortex A5 64 bits	●
Memory	Internal External	512 MB Flash, 512 MB RAM MicroSD up to 32GB	● Option
OS		Telium Tetra OS	●
SAM		3	●
Cards readers	Magstripe Smart card Contactless	ISO 1/2/3, 500K lifespan EMV Level 1, 500K lifespan EMV Level 1 compliant	● ● ●
Display	Color	3.5" backlit LCD, HVGA (480 x 320 pixels)	●
Touchscreen	Resistive Capacitive	Finger & stylus (300k lifespan signature) Finger & stylus (1000k lifespan signature)	● Option
Keypad		15 keys, raised Marking, backlit	●
Audio	Buzzer Audio jack Speaker	Stereo Mono	● Option Option
Video	Video accelerator	H264 codec	●
Terminal connectivity	Wired	Ethernet 10/100 base T	●
Terminal connections	USB Serial	USB Host 2nd USB Host USB Slave 1 R232	● Option ● ●
Power supply	Powered USB Powered R232 Powered Ethernet External power supply	5V 12V (USB retail) 12V PoE 802.3af compliant	Option ● ● Option Option

● SEAMLESS PAYMENT

Terminal size		186x110x42 mm (7.3x4.3x1.7")	●
Weight		350 g (12.3 oz)	●
Environment	Operating Temperature Storage Temperature Operating Humidity	0°C to 45°C (32°F to 113°F) -20°C to +55°C (-4°F to 131°F) 85% non-condensing at +40°C (104°F)	● ● ●
Accessory	Privacy shield	Factory mounted	Option
Security		PCI PTS 4.x Online & Offline ready	●

The terminal is intended for internal use only.

3_3_2 Power characteristics

The Lane/5000 can be powered by several ways:

- An external power supply unit. See the list of the authorized power supply units in §3_1 page 6.
- By POE (Power over Ethernet)
- By USB (5VDC or 12VDC)

POE (Power over Ethernet)

The power sourcing equipment must be compliant with IEEE802.3af standard, class 0 which means 12.95W max. POE implementation in the Lane 5000 can support both mode A and mode B.

USB

Lane/5000 needs 3.5W at 5V for good performances. Some options are not supported at 5V (Dual head, camera, Wifi, Bluetooth).

WARNING



The Lane/5000 is not strictly compliant with standard USB 5V 500mA.

Functional test has to be performed with your equipment to confirm that it can supply the required power and that transactions can be done without issues. If not, it will be necessary to use an external power supply unit.

● SEAMLESS PAYMENT

3_3_3 Terminal Connectivity

USB	High speed USB Device in the single connector
Ethernet	10/100 Base T Ethernet is available on the Lane/5000. It is recommended to use TCP Protocol
RS232	It is a 2 wire interface on the Lane/5000 (Rx/Tx). It can run up to 115200bps

● SEAMLESS PAYMENT

4_Installation

4_1 positioning the terminal

Install the terminal on a flat surface, with an easy access to an electrical outlet. Place the terminal away from any heat source and protected from dust, vibrations and electromagnetic radiations (away from video terminals, PC, anti-shoplifting barriers ...). The terminal is exclusively made for indoor use.

The Lane/5000 device may be mounted on a flat surface, wall, or customer stand.



CAUTION

Do not place the Lane/5000 device on a PC monitor, adjacent to an electronically active security tag deactivation system, or near other sources of magnetic fields.

The Lane/5000 device must be at least 30 centimeters (12 inches) away from an electronically active type of security tag deactivation pad.

- > An electronically active system sends out a powerful and potentially disruptive signal to deactivate the security tag. If the Lane/5000 device is placed too close to the system's pad, or placed above the pad, the product may not work properly.
- > A passive system is a permanent magnet type that does not send out a signal. This type should not affect the Lane/5000 device.

Operating conditions

Ambient temperature	from 0°C to +45°C
Max relative humidity	85% RH non-condensing at +40°C
Max altitude	2000 m

Storage conditions

Storage temperature	-20°C, +55°C
Max relative humidity	85% at +55°C



This equipment should be installed and operated so that the radiator is kept at least 20 cm or more away from a person's body excluding extremities.

● SEAMLESS PAYMENT

4_2 Connections

Here are all the connections on the terminal.
The SAMs and the Micro SD.

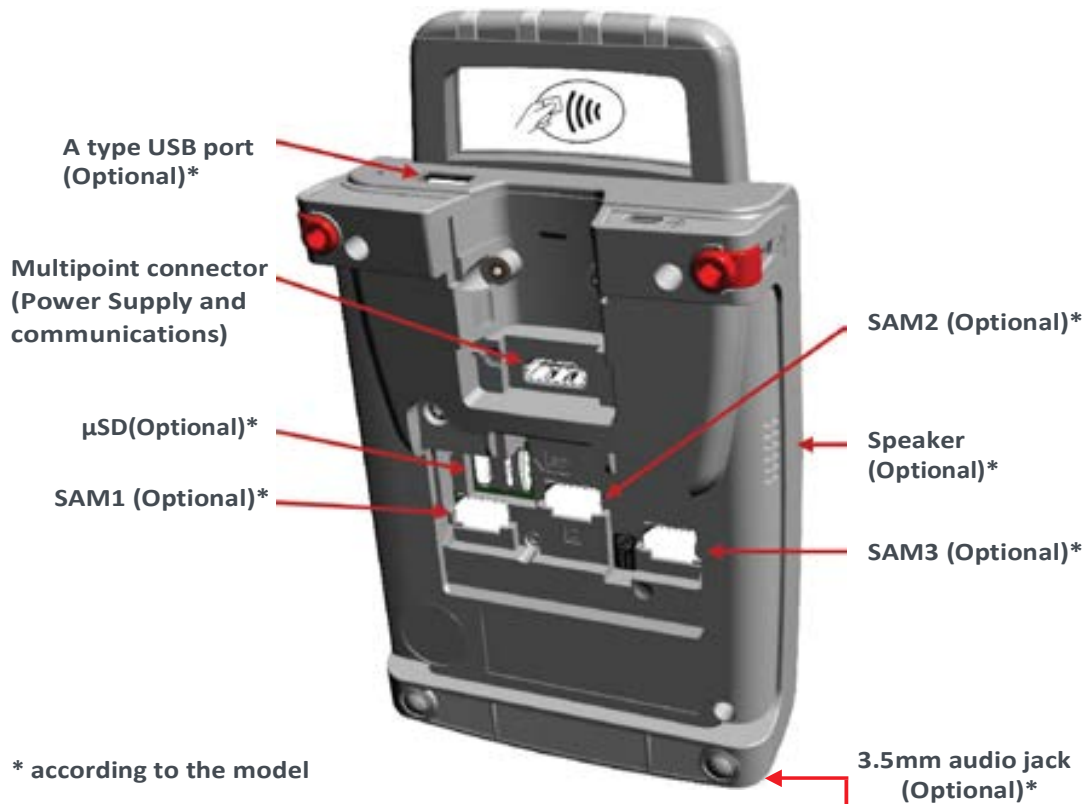

4_3 Installing the Terminal

4_3_1 Installing SAM (Secure access module, optional)



CAUTION

Before starting, switch off the terminal by disconnecting the cable.

Perform the following operations:

- > Open the trapdoor
 - Unclip the trapdoor by pushing down on the clip **1** with your finger as shown on the figure hereafter.
 - Then lift the trapdoor to remove it.



- > Insert the SAM Card into the slot marked **1**, **2**, or **3**. Take care to ensure that the SAM Card is inserted in the correct manner. The cut corner must be positioned as indicated on the figure below.

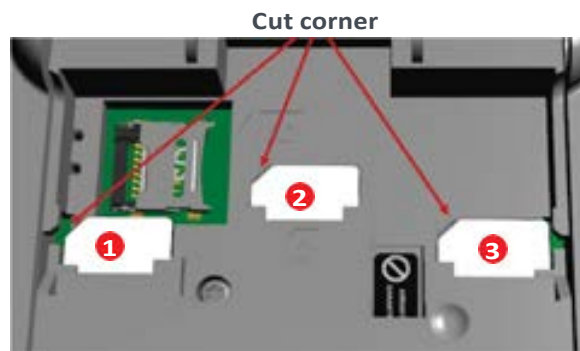

● SEAMLESS PAYMENT

- Close down side trapdoor
To close the trapdoor, put the trapdoor onto the bottom casing, and then push it upward to clip it.



CAUTION

Do not use any tools when installing or removing the SAM Card.

4_3_2 Installing MicroSD Card (optional)



CAUTION

Before starting, switch off the terminal by disconnecting the cable.

Perform the following operations:

- Open the trapdoor
 - Unclip the trapdoor by pushing down on the clip **1** with your finger as shown on the figure hereafter.
 - Then lift the trapdoor to remove it.



- Slide the metallic part on the left and lift it up to open the card holder, marked (SD)
- Insert completely the MicroSD Card into the slot as indicated on the figure.
The contacts must be positioned down side.

- Close down the card holder and push it to the right until it clicks shut.

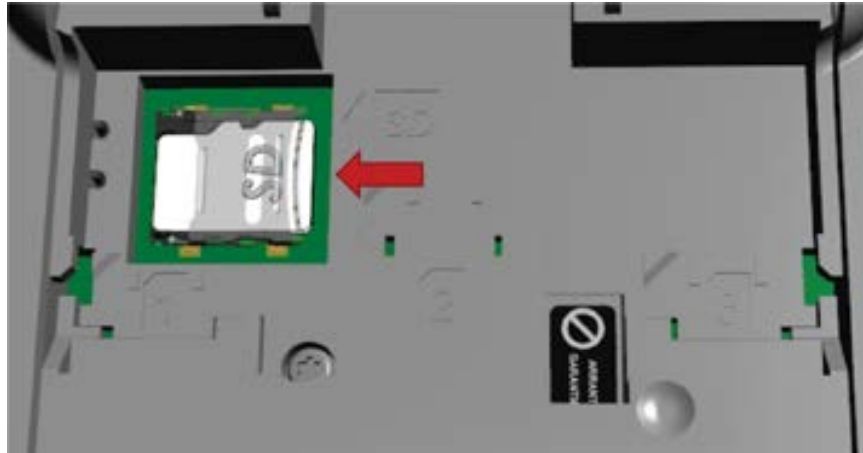

- Close down side trapdoor. Put the trapdoor onto the bottom casing, and then push it upward to clip it.

4_3_3 Connecting the terminal to the host



CAUTION

Connecting must be made when the terminal is powered off.

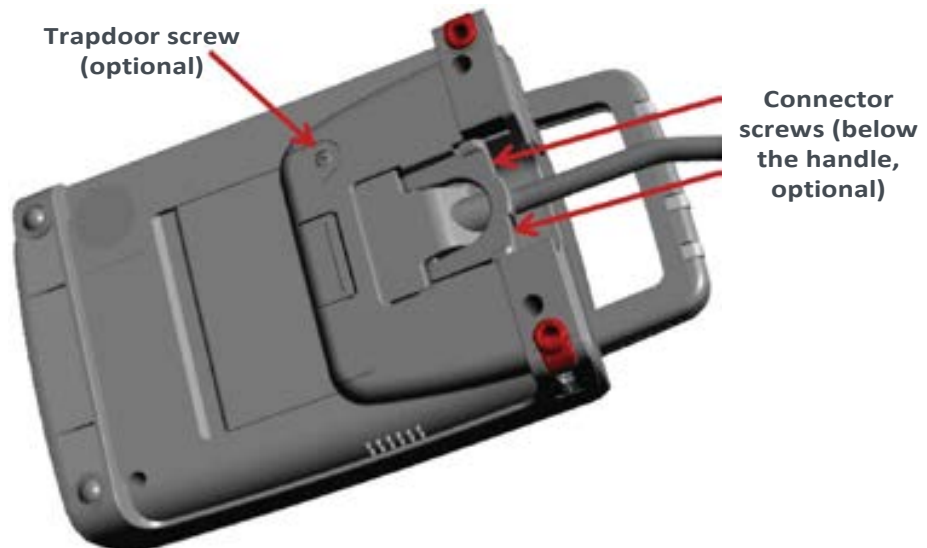

● SEAMLESS PAYMENT

- > Flip the terminal. There is one single port on the back for power and communications.
- > Connect the cable on this port of the Lane/5000.
- > Connect the other end to the power supply unit.
- > Plug the power supply into the mains.



WARNING

The main port at the back must not be used to connect a standard video HDMI cable.
Only connect cables validated for the Lane/5000 by Ingenico.

Note: screws can be added by the customer to hold more firmly the trapdoor and the connector (refer to their locations on the figure above).

The terminal can be connected to the host by several ways, with optional cables :

- High speed USB device
- Ethernet
- RS232

Most of the cables used with iSC and iPP ranges are compatible with the Lane/5000. We advise to check with your reseller their compatibility if you plan to replace an iSC or an iPP by a Lane/5000.

Following are some examples of accessories that can be used to connect the Lane/5000. This list is not exhaustive. Please contact your reseller for more information.

- **Com Box kit installation (optional)**

Reference : 296148891AD

This installation kit includes a communication cable (ref. 296141785AC) to connect the terminal to the Com Box, which dispatches on standard communication connectors :

- 2 USB ports (1 Host, 1 Device)
- 1 RS485 serial link (not usable on Lane/5000)
- 1 RS232 serial link
- 2 Ethernet ports
- 1 power lead

● SEAMLESS PAYMENT

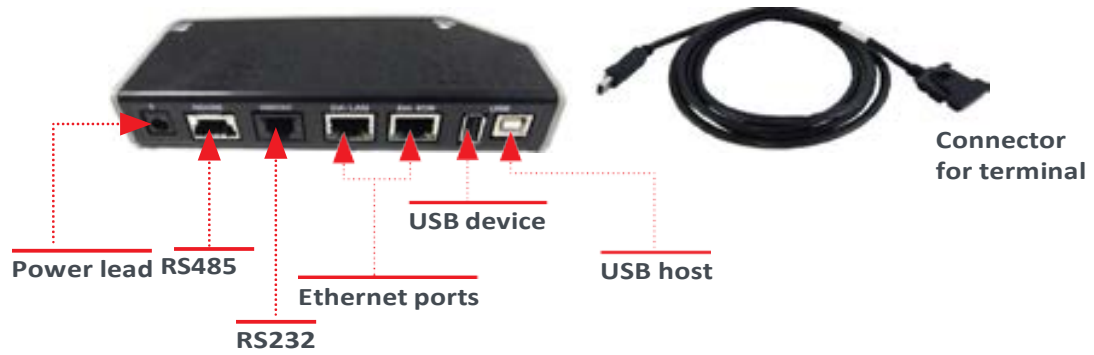

- > **RS232 cable (optional)**
References: 296114811AB (length 2m)
296114928AB (length 5m)



- > **USB cable (optional)**
References: 296111170AD (length 2m)
296114303AD (length 4m)

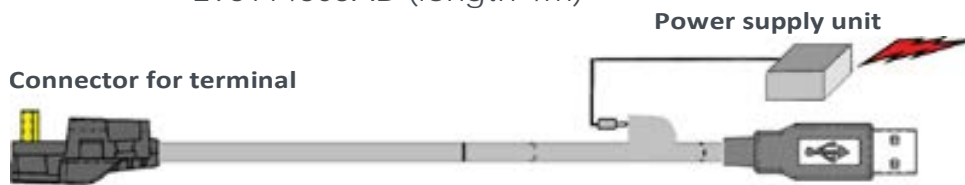

- > **USB powered 12V cable (optional)**
References: 296178419AB (length 2m)

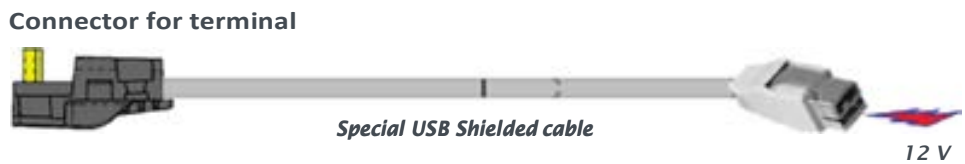

- > **Ethernet cable (optional)**
Reference : 296114829AC (length 2m)



● SEAMLESS PAYMENT

4_4 USB port (optional)

- There is an A type USB connector on the terminal, located on the rear side, below the contactless antenna (see picture hereafter).
- Open the rubber trap to access it.
- This port manages Host connections, to connect an USB flash drive or another device.



4_5 Stylus Pen (optional)

- The stylus pen and its holder must be installed on the left side of the terminal.
- Remove the adhesive protection, insert the pin of the holder inside the Kensington hole, and press firmly in place.
- A magnet in the holder keeps the stylus in position.
- Use the stylus type corresponding to the screen type (resistive or capacitive)



Part numbers : 296219137 – for resistive stylus kit (grey Soft Grip)

296219158 – for capacitive stylus kit (RED Soft Grip)



WARNING

We recommend to the customer to provide guidance to the cardholder as to avoid having his card close to any magnets on the device since the card may be damaged. There is one magnet in the stylus and another in its holder.

● SEAMLESS PAYMENT

5_Daily use

5_1 Card reading

5_1_1 Swiping a card

- Insert the card manually in the reader, magnetic stripe facing the main body of the terminal, and slide the card from the rear to the front in a continuous motion for best results.
- When sliding the card through the reader, make sure that the magnetic stripe on the card is facing the Lane/5000 display screen (see Swiping a Magnetic Stripe Card).



Swipe the card with constant speed, neither too slowly nor too fast, to maximize the reading efficiency

5_1_2 Inserting a smart card

- Chip cards should be inserted into your terminal as illustrated with the chip facing up and into the card reader.



5_1_3 Reading a contactless card

- Bring the card to the active zone above the contactless logo (at about 1cm).
- Keep the card close to the contactless logo during the transaction.



● SEAMLESS PAYMENT

Your contactless reader provides four contactless status lights located above the contactless logo.

- When a contactless transaction is started the first (left hand) status light will be lit steadily; this indicates that the contactless is in use but a card is not being read.
- When a contactless card is presented to the contactless active zone during a transaction the second, third and fourth status lights will be lit in turn. The card read is successful when all four status lights are lit and a confirmation tone can be heard.



Contactless status lights



CAUTION

Do not stick any label onto the contactless active zone. It can decrease contactless efficiency.



CAUTION

Avoid metallic parts around the contactless area.

5_2 Keyboard details and functionality



The red key cancels the procedure in progress

The yellow key cancels the last character

The green key validates input selections and information. It is also used to switch on the terminal

● SEAMLESS PAYMENT

5_3 Signature capture (optional)

- The signature capture is handled with the optional stylus.
- Make sure that the correct stylus type (resistive or capacitive) is used with the corresponding touchscreen type, as a resistive stylus is not working with a capacitive screen.



5_4 Audio jack (optional)

- The audio jack  is located next to the smart card reader.
- This option is not designed to play music, but to facilitate the use of the Lane/5000.
- The audio connector is a standard 3.5mm Audio jack, (impedance is 32 ohms)



audio
connector

● SEAMLESS PAYMENT

6_Maintenance



CAUTION

Before making any operations of maintenance in the terminal, make sure that the power supply is disconnected.

6_1 Cleaning of the terminal

The outside of the terminals are susceptible to environmental pollutants, as well as accidental spills or mishaps. It is just as important to clean the outside of the Ingenico terminal, with a safe and approved product, as it is to clean the inside. The Ingenico dual wipe has both a cleaning wipe for removing everyday contaminants and a dry wipe to completely remove any remaining dirt or solution.

Clean equipment will function better than equipment that has been neglected. When used properly, Ingenico cleaning cards and wipes should prolong equipment life and minimize card read errors.

Today's monitors should not be cleaned with standard glass cleaners that contain chemicals too harsh for these sensitive screens: plasma television screens, LCD and LED monitors, touch screen monitors and POS screens all fall under this category. Ingenico dual wipes are designed specifically for these type of monitors; removing dust, fingerprints, oils or other contaminants that will distort the image on your screen. The Ingenico dual wipe has both a cleaning wipe for removing everyday contaminants and a dry wipe to completely remove any remaining dirt or solution.

This product works best when the screen is cool, so before use turn the monitor/system off.

This product can be used by anyone who can use a card reader terminal, just:

- Remove the Step 1 cleaning wipe from pouch.
- Wipe down the screen first, then the keypad, top and sides of the terminal.
- Remove the Step 2 dry wipe from pouch.
- Wipe down the screen first, then the keypad, top and sides of the terminal.
- You may use both wipes to clean other areas of your POS equipment if necessary.
- Discard the cleaning wipes properly.

For more information, visit our website <http://ingenico.cleaningcards.com>

● SEAMLESS PAYMENT



CAUTION

Do not use in any case, **solvents, detergents** or **abrasive products:**

those materials might damage the plastic or electrical contacts.

- Avoid exposing the terminal to the direct rays of the sun.
- Do not put anything into the slot of the smart card reader

6_2 Transport and storage

- Use the original packaging for storage or returning the unit.
- Disconnect all cables from the terminal during the transport.

6_3 Troubleshooting

Device is not working

- When sliding the card through the reader, make sure that the magnetic stripe on the card is facing the Lane/5000 display screen (see *Swiping a Magnetic Stripe Card* section 5.1.1)
- Make sure that the Lane/5000 connector is fully inserted into the back of the device.
- Restart the device.
- If you have another working Lane/5000 device, swap the devices to determine if the problem is with the device, cable, POS, or power supply.
- If the Lane/5000 device is directly connected to a host, reset the host by turning it off and back on again.

Magnetic Card Reader Does Not Work Properly

- Swipe the card at a faster or middle steady speed.
- Inspect the magnetic stripe on the card to make sure it is not damaged or badly worn.
- Security tag deactivation system could disturb the magnetic card reader
- To determine if the problem is with the card :
 - a. If your host device has a magnetic stripe reader, try swiping the card there.
 - b. If you have another working Lane/5000 device, try swiping the card there.

● SEAMLESS PAYMENT

Smart Card Reader Does Not Work Properly

- Make sure you have inserted correctly the smart card into the smart card reader and removed the card only after the transaction

MicroSD Card Reader Does Not Work Properly

- Make sure you have inserted correctly the microSD card into the card reader.
- Check that the card capacity is not higher than 32GB.
- Micro SD hotplug is not recommended. Try to reboot the Lane/5000

Stylus Does Not Work Properly

- Make sure you use the correct stylus version corresponding to the screen type. A resistive stylus will not work on a capacitive screen.



WARNING

Changes or modifications to this device not expressly approved by the party responsible for compliance could void the user's authority to operate the equipment.

6_4 Environment (WEEE, Batteries and Packaging)

This product is labelled in accordance with European Directives 2012/19/UE concerning Waste Electrical and Electronic Equipment (WEEE) and 2006/66/EC concerning Batteries and Accumulators. Those provisions are requiring producers and manufacturers to become liable for take-back, treatment and recycling upon end of life of equipment and batteries.



The associated symbol means that WEEE and waste batteries must not be thrown away but collected separately and recycled.

Ingenico ensures that efficient collection and recycling schemes are set-up for WEEE and batteries according to the local regulation of your country. Please contact your resellers for more detailed information about the compliance solution in place for disposing of your old product and used batteries.

● SEAMLESS PAYMENT

Packaging waste must also be collected separately to assure a proper disposal and recycling.

Please note that proper recycling of the electrical and electronic equipment and waste batteries will ensure safety of human health and environment.

7_Standards

7_1 WARNING TO USERS IN THE UNITED STATES

Federal Communication Commission Interference Statement 47 CFR Section 15.105(b)

This equipment has been tested and found to comply with the limits for a Class B digital device, pursuant to Part 15 of the FCC Rules. These limits are designed to provide reasonable protection against harmful interference in a residential installation. This equipment generates uses and can radiate radio frequency energy and, if not installed and used in accordance with the instructions, may cause harmful interference to radio communications. However, there is no guarantee that interference will not occur in a particular installation. If this equipment does cause harmful interference to radio or television reception, which can be determined by turning the equipment off and on, the user is encouraged to try to correct the interference by one of the following measures :

- Reorient or relocate the receiving antenna.
- Increase the separation between the equipment and receiver.
- Connect the equipment into an outlet on a circuit different from that to which the receiver is connected.

7_2 NO UNAUTHORIZED MODIFICATIONS

Federal Communication Commission Interference Statement 47 CFR Section 15.21.

- Consult the dealer or an experienced radio/TV technician for help.



CAUTION

This equipment may not be modified, altered, or changed in any way without signed written permission from Ingenico. Unauthorized modification may void the equipment authorization from the FCC and will void the Ingenico warranty.

● SEAMLESS PAYMENT

7_3 ANTENNA REQUIREMENT

Federal Communication Commission Interference Statement 47 CFR Section 15.203.

This device complies with Part 15 of the FCC Rules. Operation is subject to the following two conditions: (1) This device may not cause harmful interference, and (2) this device must accept any interference received, including interference that may cause undesired operation.

7_4 WARNING TO USERS IN THE CANADA

This device complies with Industry Canada licence-exempt RSS standard(s). Operation is subject to the following two conditions : (1) this device may not cause interference, and (2) this device must accept any interference, including interference that may cause undesired operation of the device.

Under Industry Canada regulations, this radio transmitter may only operate using an antenna of a type and maximum (or lesser) gain approved for the transmitter by Industry Canada.

To reduce potential radio interference to other users, the antenna type and its gain should be so chosen that the equivalent isotropically radiated power (e.i.r.p.) is not more than that necessary for successful communication

7_5 Markings

The CE marking indicates that the terminal complies with harmonized standards and requirements of European Directives on:

- Radio and Telecommunications Terminal Equipment (R&TTE)
- the protection of the health and the safety of the user and any other person.
- the protection requirements with respect to electromagnetic compatibility.
- RoHS (Restriction of Hazardous Substances)



The CE marking is the manufacturer's declaration that the product meets the requirements of the applicable EC directives. The CE mark is a mandatory conformity marking for certain products sold within the European Economic Area (EEA).



This TÜV symbol shows consumers at a glance that a product has been examined by neutral experts and that there are no safety concerns.

● SEAMLESS PAYMENT



The UL mark appears on end products and complete components suitable for factory and field installation. All of the products carrying these marks are covered by our Follow-Up Services program to determine that products continue to be manufactured in compliance with UL's safety requirements.



The RCM mark will be the only mark to indicate compliance with the Australian Communications and Media Authority's (ACMA) regulatory arrangements for telecommunications, radio, EMC and electromagnetic energy (EME).

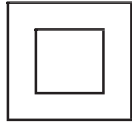

Double insulated or class 2 electrical appliances are products that have been designed in a way so as not to require a safety connection to electrical earth (These products must NOT have a safety connection to Earth).



This logo indicates that the product operates with a continuous voltage. This symbol is followed by the ratings (voltage and current for instance).

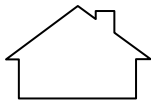

Indoor use symbol.



Mark indicating a power supply meets the Level VI requirements.

IS 13252 (Part 1)
IEC 60950-1



India's Compulsory Registration Scheme (CRS) for Electronic Products.

R-41017175



This logo indicates that the product operates with an alternative voltage. This symbol is followed by the ratings (voltage and current for instance).



The Electrical Appliance and Material Safety Law applies to enterprises that manufacture or import products in Japan.



China Compulsory Certification (CCC) is similar to other certifications for product quality standardization—such as the European CE system.

● SEAMLESS PAYMENT

"This Document is Copyright © 2015 by INGENICO Group. INGENICO retains full copyright ownership, rights and protection in all material contained in this document. The recipient can receive this document on the condition that he will keep the document confidential and will not use its contents in any form or by any means, except as agreed beforehand, without the prior written permission of INGENICO. Moreover, nobody is authorized to place this document at the disposal of any third party without the prior written permission of INGENICO. If such permission is granted, it will be subject to the condition that the recipient ensures that any other recipient of this document, or information contained therein, is held responsible to INGENICO for the confidentiality of that information.

Care has been taken to ensure that the content of this document is as accurate as possible. INGENICO however declines any responsibility for inaccurate, incomplete or outdated information. The contents of this document may change from time to time without prior notice, and do not create, specify, modify or replace any new or prior contractual obligations agreed upon in writing between INGENICO and the user.

INGENICO is not responsible for any use of this device, which would be non-consistent with the present document.

All trademarks used in this document remain the property of their rightful owners."

Your contact



www.ingenico.com

28-32, boulevard de Grenelle, 75015 Paris - France / (T) +33 (0)1 58 01 80 00 / (F) +33 (0)1 58 01 91 35
Ingenico - SA au capital de 47 656 332 / 317 218 758 RCS Nanterre

● SEAMLESS PAYMENT

Lane/5000
900021971 R11 000 05/0917

29

Copyright © 2017 Ingenico
All rights reserved